

optibelt ZR / ZR D

The most salient features of the Optibelt ZR timing belts are the high quality neoprene compounds, the extremely flexible tension cords made of glass fibre and the abrasion-resistant protective fabric. A certain level of oil, heat and cold resistance are standard features of ZR timing belts.

Advantages

- Synchronous torque transmission
- Broad performance range
- Low bearing loading
- High level of flexibility
- Extremely small pulley diameters

Customised versions tailored to a particular application can be provided on request.

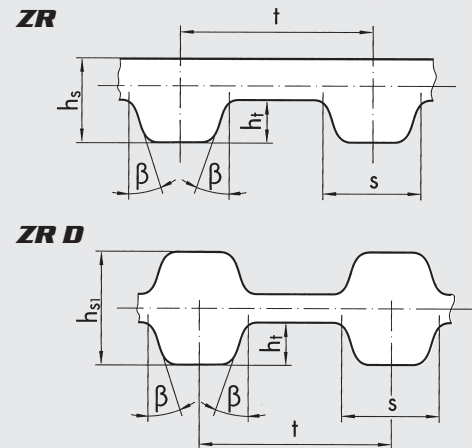

Sections:

ZR: MXL; XL; L; H; XH; XXH

ZR D: D-XL; D-L; D-H

ZR: endless timing belts
XL; L; H

Dimensions:

ZR: 91 to 4 572 mm

ZR D: 381 to 4 318 mm
other sizes on request

Timing pulleys Optibelt ZRS:

standard timing pulleys for cylindrical bores ZR: XL; L; H; XH
standard timing pulleys for taper bushes ZR: L; H; XH
special pulleys on request

Examples of Applications

- | | |
|----------------------------------|------------------------|
| Office equipment | ■ Copiers |
| Data processing | ■ Printers |
| Household appliances | ■ Mixers |
| Gardening equipment | ■ Scarifiers, aerators |
| Film and photographic technology | ■ Film cameras |
| D.I.Y. tools | ■ Planes |
| Packing machines | ■ Measuring drives |
| Conveying technology | ■ Control unit drives |

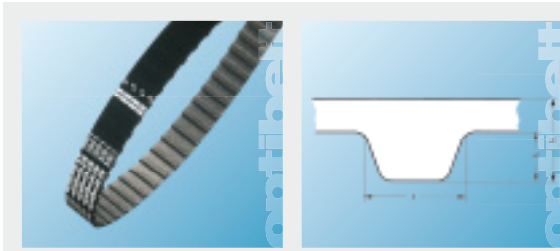

	h_t [mm]	s [mm]	h_s [mm]
MXL	0,51	1,14	1,20
XL	1,27	2,57	2,30

MXL				XL			
Wirklänge Pitch length [mm]	Anzahl der Zähne Number of teeth	Wirklänge Pitch length [mm]	Anzahl der Zähne Number of teeth	Wirklänge Pitch length [mm]	Anzahl der Zähne Number of teeth	Wirklänge Pitch length [mm]	Anzahl der Zähne Number of teeth
360	45	1112	139	60	30	194	97
432	54	1120	140	70	35	196	98
440	55	1136	142	80	40	200	100
448	56	1176	147	86	43	210	105
456	57	1184	148	88	44	220	110
464	58	1200	150	90	45	230	115
480	60	1224	153	92	46	240	120
488	61	1272	159	94	47	244	122
536	67	1280	160	96	48	248	124
544	68	1320	165	98	49	250	125
560	70	1360	170	100	50	260	130
568	71	1400	175	102	51	270	135
576	72	1440	180	106	53	272	136
600	75	1472	184	108	54	274	137
608	76	1520	190	110	55	280	140
632	79	1560	195	112	56	286	143
640	80	1600	200	116	58	290	145
656	82	1768	221	118	59	296	148
664	83	1800	225	120	60	300	150
672	84	1888	236	124	62	306	153
680	85	1984	248	126	63	310	155
704	88	1992	249	128	64	316	158
720	90	2008	251	130	65	320	160
728	91	2048	256	134	67	322	161
736	92	2144	268	136	68	330	165
752	94	2240	280	138	69	340	170
760	95	2384	298	140	70	344	172
776	97	2480	310	142	71	350	175
800	100	2520	315	148	74	360	180
808	101	2680	335	150	75	380	190
816	102	2776	347	156	78	382	191
824	103	2880	360	160	80	388	194
840	105	2920	365	162	81	390	195
848	106	3200	400	166	83	392	196
856	107	3472	434	168	84	412	206
864	108	3624	453	170	85	414	207
880	110	3704	463	174	87	432	216
896	112	3984	498	176	88	434	217
904	113	4040	505	178	89	438	219
912	114			180	90	460	230
920	115			182	91	498	249
960	120			184	92	506	253
976	122			188	94	514	257
984	123			190	95	580	290
1000	125			192	96	630	315
1008	126						
1040	130						
1056	132						
1072	134						
1080	135						

Bestellbeispiel <i>Order example</i>	Produkt Product	Wirklänge Pitch length [mm]	Profil/Ausführung Profile and model	Breite Belt width [Zoll inch]	
Optibelt ZR	Zahnriemen Timing Belt	1000	MXL	1/8"	

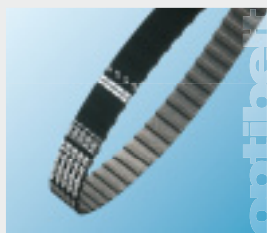

	h_t [mm]	s [mm]	h_s [mm]
L	1,91	4,65	3,60
H	2,29	6,12	4,00

L		H			
Wirklänge Pitch length [mm]	Anzahl der Zähne Number of teeth	Wirklänge Pitch length [mm]	Anzahl der Zähne Number of teeth	Wirklänge Pitch length [mm]	Anzahl der Zähne Number of teeth
109	29	230	46	820	164
124	33	240	48	850	170
150	40	255	51	860	172
165	44	270	54	900	180
169	45	280	56	950	190
173	46	300	60	1000	200
187	50	310	62	1100	220
202	54	315	63	1120	224
210	56	320	64	1140	228
225	60	330	66	1150	230
232	62	335	67	1250	250
236	63	340	68	1400	280
240	64	350	70	1700	340
255	68	360	72		
259	69	370	74		
263	70	375	75		
270	72	390	78		
285	76	400	80		
300	80	410	82		
322	86	420	84		
345	92	430	86		
360	96	450	90		
367	98	465	93		
375	100	480	96		
390	104	490	98		
405	108	510	102		
420	112	520	104		
424	113	530	106		
427	114	540	108		
435	116	560	112		
450	120	570	114		
454	121	580	116		
480	128	600	120		
510	136	630	126		
525	140	650	130		
540	144	660	132		
600	160	670	134		
630	168	680	136		
660	176	700	140		
		720	144		
		730	146		
		750	150		
		770	154		
		800	160		
		810	162		

Bestellbeispiel Order example	Produkt Product	Wirklänge Pitch length [mm]	Profil/Ausführung Profile and model	Breite Belt width [Zoll inch]	
Optibelt ZR	Zahnriemen Timing Belt	660	L	1/2"	

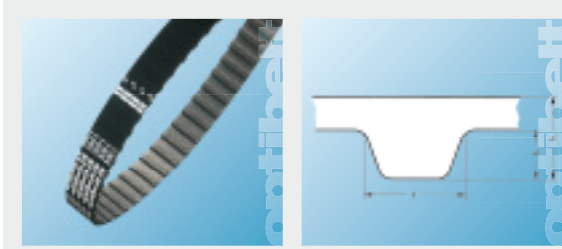

	h_t [mm]	s [mm]	h_s [mm]
XH	6,35	12,57	11,20
XXH	9,53	19,05	15,70

XH		XXH	
Wirklänge Pitch length [mm]	Anzahl der Zähne Number of teeth	Wirklänge Pitch length [mm]	Anzahl der Zähne Number of teeth
507	58	700	56
560	64	800	64
630	72	900	72
700	80	1000	80
770	88	1200	96
840	96	1400	112
980	112	1600	128
1120	128	1800	144
1260	144		
1400	160		
1540	176		
1750	200		

Bestellbeispiel <i>Order example</i>	Produkt Product	Wirklänge Pitch length [mm]	Profil/Ausführung Profile and model	Breite Belt width [Zoll inch]	
Optibelt ZR	Zahnriemen Timing Belt	1800	XXH	2"	